

Dear Deck Builder,

We wanted to send you this letter to make you aware of the changes to the Residential Code of Ohio that become effective July 1, 2019 as they relate to deck construction in the County. Historically, the code did not have many prescriptive references to deck construction but with the 2019 Ohio Residential Code of Ohio adopted by the State Board of Building Standards there is now a new section 507 that gives prescriptive requirements for deck construction. A few highlights that we want to bring your attention to include:

- Table 507.3.1 provides for minimum sizes for deck footings, this table represents a large expansion from the current code.
- Table 507.4 provides for maximum height of deck posts depending on post size.
- Table 507.5 is a new span table just for deck beams.
- Section 507.5.1 and 507.5.2 requires each ply of deck beams to bear **directly on top of posts** and attached in accordance with figure 507.5.1(1). Bolting to the sides of posts will no longer be permitted.

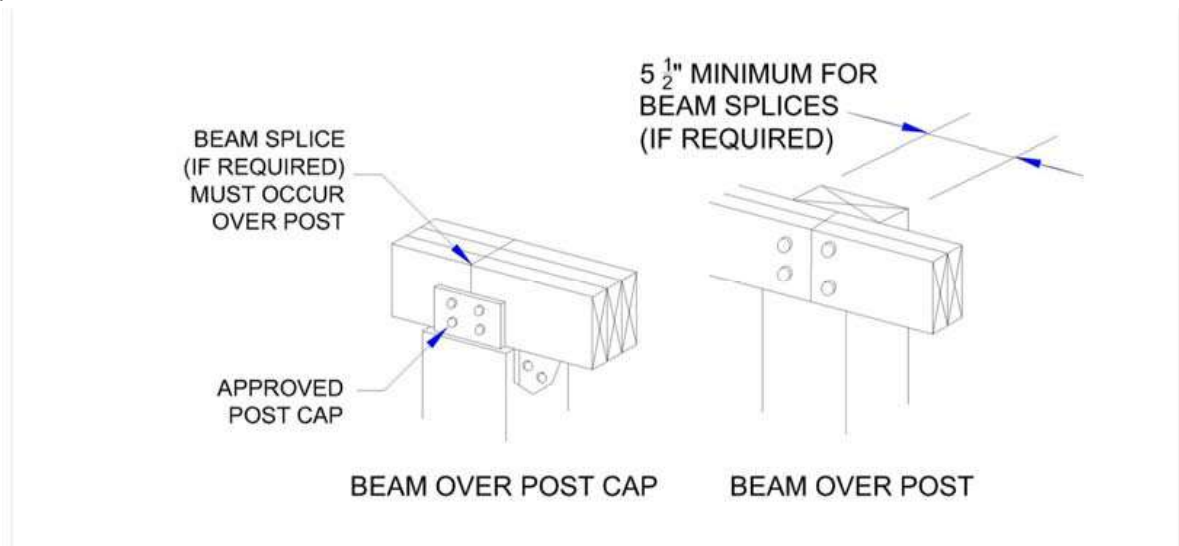

- Table 507.6 provides for a span chart for deck joist spans only.
- Table 507.9.1.3(1) provides for on center spacing for ledger connections depending on joist spans.

We have provided a link on our website with the new section 507 for your reference. Any deck application received on or after July 1 will be required to comply with these new requirements. As always we are available to answer any questions you may have with the new State requirements.

Kindest regards,

Christopher Randles

Christopher Randles
Chief Building Official

Ken Neumeyer

Ken Neumeyer
Residential Building Official

SECTION 507
EXTERIOR DECKS

507.1 Decks. Wood-framed decks shall be in accordance with this section. For decks using materials and conditions not prescribed in this section, refer to Section 301.

507.2 Materials. Materials used for the construction of decks shall comply with this section.

507.2.1 Wood materials. Wood materials shall be No. 2 grade or better lumber, preservative-treated in accordance with Section 317, or approved, naturally durable lumber, and termite protected where required in accordance with Section 318. Where design in accordance with Section 301 is provided, wood structural members shall be designed using the wet service factor defined in AWC NDS. Cuts, notches and drilled holes of preservative-treated wood members shall be treated in accordance with Section 317.1.1. All preservative-treated wood products in contact with the ground shall be labeled for such usage.

507.2.1.1 Engineered wood products. Engineered wood products shall be in accordance with Section 502.

507.2.2 Plastic composite deck boards, stair treads, guards, or handrails. Plastic composite exterior deck boards, stair treads, guards and handrails shall comply with the requirements of ASTM D7032 and this section.

507.2.2.1 Labeling. Plastic composite deck boards and stair treads, or their packaging, shall bear a label that indicates compliance with ASTM D7032 and includes the allowable load and maximum allowable span determined in accordance with ASTM D7032. Plastic or composite handrails and guards, or their packaging, shall bear a label that indicates compliance with ASTM D7032 and includes the maximum allowable span determined in accordance with ASTM D7032.

507.2.2.2 Flame spread index. Plastic composite deck boards, stair treads, guards, and handrails shall exhibit a flame spread index not exceeding 200 when tested in accordance with ASTM E84 or UL 723 with the test specimen remaining in place during the test.

Exception: Plastic composites determined to be noncombustible.

507.2.2.3 Decay resistance. Plastic composite deck boards, stair treads, guards and handrails containing wood, cellulosic or other biodegradable materials shall be decay resistant in accordance with ASTM D7032.

507.2.2.4 Termite resistance. Where required by Section 318, plastic composite deck boards, stair treads, guards and handrails containing wood, cellulosic or other biodegradable materials shall be termite resistant in accordance with ASTM D7032.

507.2.2.5 Installation of plastic composites. Plastic composite deck boards, stair treads, guards and handrails shall be installed in accordance with this code and the manufacturer’s instructions.

507.2.3 Fasteners and connectors. Metal fasteners and connectors used for all decks shall be in accordance with Section 317.3 and Table 507.2.3.

**TABLE 507.2.3
FASTENER AND CONNECTOR SPECIFICATIONS FOR DECKS ^{a, b}**

<u>ITEM</u>	<u>MATERIAL</u>	<u>MINIMUM FINISH/COATING</u>	<u>ALTERNATE FINISH/COATING ^c</u>
<u>Nails and timber rivets</u>	<u>In accordance with ASTM F1667</u>	<u>Hot-dipped galvanized per ASTM A153</u>	<u>Stainless steel, silicon bronze or copper</u>
<u>Bolts ^c Lag screws ^d (including nuts and washers)</u>	<u>In accordance with ASTM A307 (bolts), ASTM A563 (nuts), ASTM F844 (washers)</u>	<u>Hot-dipped galvanized per ASTM A153, Class C (Class D for 3/8 -inch diameter and less) or mechanically galvanized per ASTM B695, Class 55 or 410 stainless steel</u>	<u>Stainless steel, silicon bronze or copper</u>
<u>Metal connectors</u>	<u>Per manufacturer’s specification</u>	<u>ASTM A653 type G185 zinc coated galvanized steel or post hot-dipped galvanized per ASTM A123 providing a minimum average coating weight of 2.0 oz./ft² (total both sides)</u>	<u>Stainless steel</u>

For SI: 1 inch = 25.4 mm, 1 foot = 304.8 mm.

- a. Equivalent materials, coatings and finishes shall be permitted.
- b. Fasteners and connectors exposed to salt water or located within 300 feet of a salt water shoreline shall be stainless steel.
- c. Holes for bolts shall be drilled a minimum 1/32 -inch and a maximum 1/16 -inch larger than the bolt.
- d. Lag screws 1/2 -inch and larger shall be predrilled to avoid wood splitting per the National Design Specification (NDS) for Wood Construction.
- e. Stainless-steel-driven fasteners shall be in accordance with ASTM F1667.

507.2.4 Flashing. Flashing shall be corrosion-resistant metal of nominal thickness not less than 0.019 inch (0.48 mm) or approved nonmetallic material that is compatible with the substrate of the structure and the decking materials.

507.2.5 Alternate materials. Alternative materials, including glass and metals, shall be permitted.

507.3 Footings. Decks shall be supported on concrete footings or other approved structural systems designed to accommodate all loads in accordance with Section 301. Deck footings shall be sized to carry the imposed loads from the deck structure to the ground as shown in Figure 507.3. The footing depth shall be in accordance with Section 403.1.4.

Exception: Free-standing decks consisting of joists directly supported on grade over their entire length.

507.3.1 Minimum size. The minimum size of concrete footings shall be in accordance with Table 507.3.1, based on the tributary area and allowable soil-bearing pressure in accordance with Table 401.4.1.

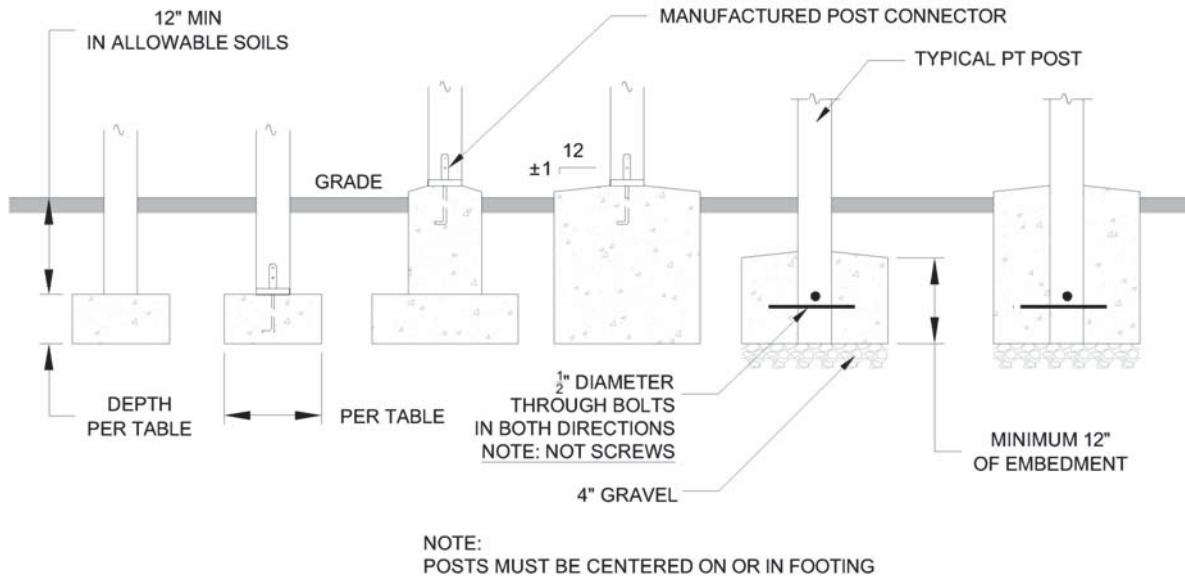

For SI: 1 inch = 25.4 mm.

FIGURE 507.3
DECK POSTS TO DECK FOOTING CONNECTION

**TABLE 507.3.1
MINIMUM FOOTING SIZE FOR DECKS**

LIVE OR GROUND SNOW LOAD ^b (psf)	TRIBUTARY AREA (sq. ft.)	LOAD BEARING VALUE OF SOILS ^{a, c, d} (psf)											
		1500 ^a			2000 ^a			2500 ^a			≥3000 ^a		
		Side of a square footing (inches)	Diameter of a round footing (inches)	Thickness (inches)	Side of a square footing (inches)	Diameter of a round footing (inches)	Thickness (inches)	Side of a square footing (inches)	Diameter of a round footing (inches)	Thickness (inches)	Side of a square footing (inches)	Diameter of a round footing (inches)	Thickness (inches)
40	20	12	14	6	12	14	6	12	14	6	12	14	6
	40	14	16	6	12	14	6	12	14	6	12	14	6
	60	17	19	6	15	17	6	13	15	6	12	14	6
	80	20	22	7	17	19	6	15	17	6	14	16	6
	100	22	25	8	19	21	6	17	19	6	15	17	6
	120	24	27	9	21	23	7	19	21	6	17	19	6
	140	26	29	10	22	25	8	20	23	7	18	21	6
160	28	31	11	24	27	9	21	24	8	20	22	7	
50	20	12	14	6	12	14	6	12	14	6	12	14	6
	40	15	17	6	13	15	6	12	14	6	12	14	6
	60	19	21	6	16	18	6	14	16	6	13	15	6
	80	21	24	8	19	21	6	17	19	6	15	17	6
	100	24	27	9	21	23	7	19	21	6	17	19	6
	120	26	30	10	23	26	8	20	23	7	19	21	6
	140	28	32	11	25	28	9	22	25	8	20	23	7
160	30	34	12	26	30	10	24	27	9	21	24	8	
60	20	12	14	6	12	14	6	12	14	6	12	14	6
	40	16	19	6	14	16	6	13	14	6	12	14	6
	60	20	23	7	17	20	6	16	18	6	14	16	6
	80	23	26	9	20	23	7	18	20	6	16	19	6
	100	26	29	10	22	25	8	20	23	7	18	21	6
	120	28	32	11	25	28	9	22	25	8	20	23	7
	140	31	35	12	27	30	10	24	27	9	22	24	8
160	33	37	13	28	32	11	25	29	10	23	26	9	
70	20	12	14	6	12	14	6	12	14	6	12	14	6
	40	18	20	6	15	17	6	14	15	6	12	14	6
	60	21	24	8	19	21	6	17	19	6	15	17	6
	80	25	28	9	21	24	8	19	22	7	18	20	6
	100	28	31	11	24	27	9	21	24	8	20	22	7
	120	30	34	12	26	30	10	24	27	9	21	24	8
	140	33	37	13	28	32	11	25	29	10	23	26	9
160	35	40	15	30	34	12	27	31	11	25	28	9	

For SI: 1 inch = 25.4 mm, 1 square foot = 0.0929 m², 1 pound per square foot = 0.0479 kPa.

- a. Interpolation permitted, extrapolation not permitted.
- b. Based on highest load case: Dead + Live or Dead + Snow.
- c. Assumes minimum square footing to be 12 inches x 12 inches x 6 inches for 6 x 6 post.
- d. If the support is a brick or CMU pier, the footing shall have a minimum 2-inch projection on all sides.
- e. Area, in square feet, of deck surface supported by post and footings.

507.3.2 Minimum depth. Deck footings shall extend below the frost line specified in Table 301.2(1) in accordance with Section 403.1.4.1.

Exceptions:

1. Free-standing decks that meet all of the following criteria:
 - 1.1. The joists bear directly on precast concrete pier blocks at grade without support by beams or posts.
 - 1.2. The area of the deck does not exceed 200 square feet (18.9 m²).
 - 1.3. The walking surface is not more than 20 inches (616 mm) above grade at any point within 36 inches (914 mm) measured horizontally from the edge.
2. Free-standing decks need not be provided with footings that extend below the frost line.

507.4 Deck posts. For single-level wood-framed decks with beams sized in accordance with Table 507.5, deck post size shall be in accordance with Table 507.4.

TABLE 507.4
DECK POST HEIGHT ^a

<u>DECK POST SIZE</u>	<u>MAXIMUM HEIGHT ^{a, b}</u> <u>(feet-inches)</u>
4 x 4	6-9 ^c
4 x 6	8
6 x 6	14
8 x 8	14

For SI: 1 inch = 25.4 mm, 1 foot = 304.8 mm.

1 pound per square foot = 0.0479 kPa.

- a. Measured to the underside of the beam.
- b. Based on 40 psf live load.
- c. The maximum permitted height is 8 feet for one-ply and two-ply beams. The maximum permitted height for three-ply beams on post cap is 6 feet 9 inches.

507.4.1 Deck post to deck footing connection. Where posts bear on concrete footings in accordance with Section 403 and Figure 507.4.1, lateral restraint shall be provided by manufactured connectors or a minimum post embedment of 12 inches (305 mm) in surrounding soils or concrete piers. Other footing systems shall be permitted.

Exception: Where expansive, compressible, shifting or other questionable soils are present, surrounding soils shall not be relied on for lateral support.

507.5 Deck Beams. Maximum allowable spans for wood deck beams, as shown in Figure 507.5, shall be in accordance with Table 507.5. Beam plies shall be fastened with two rows of 10d (3-inch x 0.128-inch) nails minimum at 16 inches (406 mm) on center along each edge. Beams shall be permitted to cantilever at each end up to one-fourth of the allowable beam span. Deck beams of other materials shall be permitted where designed in accordance with accepted engineering practices.

TABLE 507.5
DECK BEAM SPAN LENGTHS^{a, b, g} (feet - inches)

SPECIES ^c	SIZE ^d	DECK JOIST SPAN LESS THAN OR EQUAL TO:						
		(feet)						
		6	8	10	12	14	16	18
Southern pine	1-2 x 6	4-11	4-0	3-7	3-3	3-0	2-10	2-8
	1-2 x 8	5-11	5-1	4-7	4-2	2-10	3-7	3-5
	1-2 x 10	7-0	6-0	5-5	4-11	4-7	4-3	4-0
	1-2 x 12	8-3	7-1	6-4	5-10	5-5	5-0	4-9
	2-2 x 6	6-11	5-11	5-4	4-10	4-6	4-3	4-0
	2-2 x 8	8-9	7-7	6-9	6-2	5-9	5-4	5-0
	2-2 x 10	10-4	9-0	8-0	7-4	6-9	6-4	6-0
	2-2 x 12	12-2	10-7	9-5	8-7	8-0	7-6	7-0
	3-2 x 6	8-2	7-5	6-8	6-1	5-8	5-3	5-0
	3-2 x 8	10-10	9-6	8-6	7-9	7-2	6-8	6-4
	3-2 x 10	13-0	11-3	10-0	9-2	8-6	7-11	7-6
3-2 x 12	15-3	13-3	11-10	10-9	10-0	9-4	8-10	
Douglas fir-larch ^e , hem-fir ^e , spruce-pine-fir ^e , redwood, western cedars, ponderosa pine ^f , red pine ^f	3 x 6 or 2-2 x 6	5-5	4-8	4-2	3-10	3-6	3-1	2-9
	3 x 8 or 2-2 x 8	6-10	5-11	5-4	4-10	4-6	4-1	3-8
	3 x 10 or 2-2 x 10	8-4	7-3	6-6	5-11	5-6	5-1	4-8
	3 x 12 or 2-2 x 12	9-8	8-5	7-6	6-10	6-4	5-11	5-7
	4 x 6	6-5	5-6	4-11	4-6	4-2	3-11	3-8
	4 x 8	8-5	7-3	6-6	5-11	5-6	5-2	4-10
	4 x 10	9-11	8-7	7-8	7-0	6-6	6-1	5-8
	4 x 12	11-5	9-11	8-10	8-1	7-6	7-0	6-7
	3-2 x 6	7-4	6-8	6-0	5-6	5-1	4-9	4-6
	3-2 x 8	9-8	8-6	7-7	6-11	6-5	6-0	5-8
	3-2 x 10	12-0	10-5	9-4	8-6	7-10	7-4	6-11
3-2 x 12	13-11	12-1	10-9	9-10	9-1	8-6	8-1	

For SI: 1 inch = 25.4 mm, 1 foot = 304.8 mm, 1 pound per square foot = 0.0479 kPa, 1 pound = 0.454 kg.

- a. Ground snow load, live load = 40 psf, dead load = 10 psf, L/A = 360 at main span, L/A = 180 at cantilever with a 220-pound point load applied at the end.
- b. Beams supporting deck joists from one side only.
- c. No. 2 grade, wet service factor.
- d. Beam depth shall be greater than or equal to depth of joists with a flush beam condition.
- e. Includes incising factor.
- f. Northern species. Incising factor not included.
- g. Beam cantilevers are limited to the adjacent beam's span divided by 4.

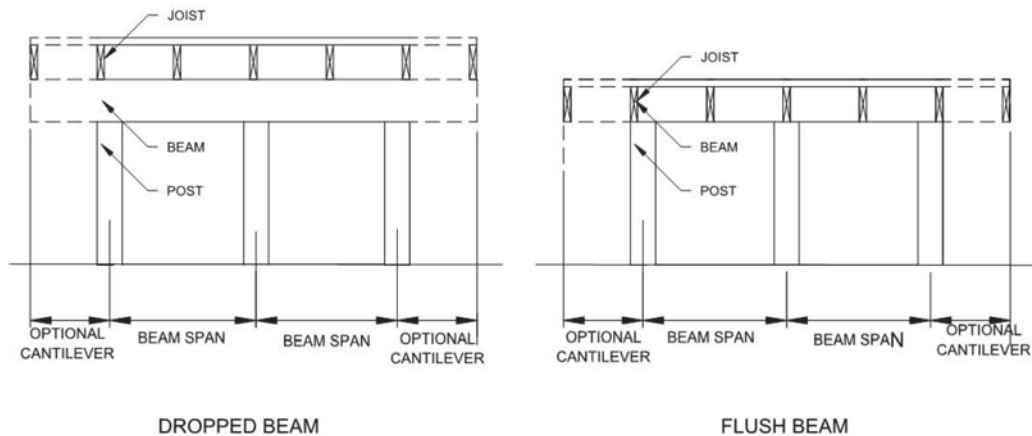
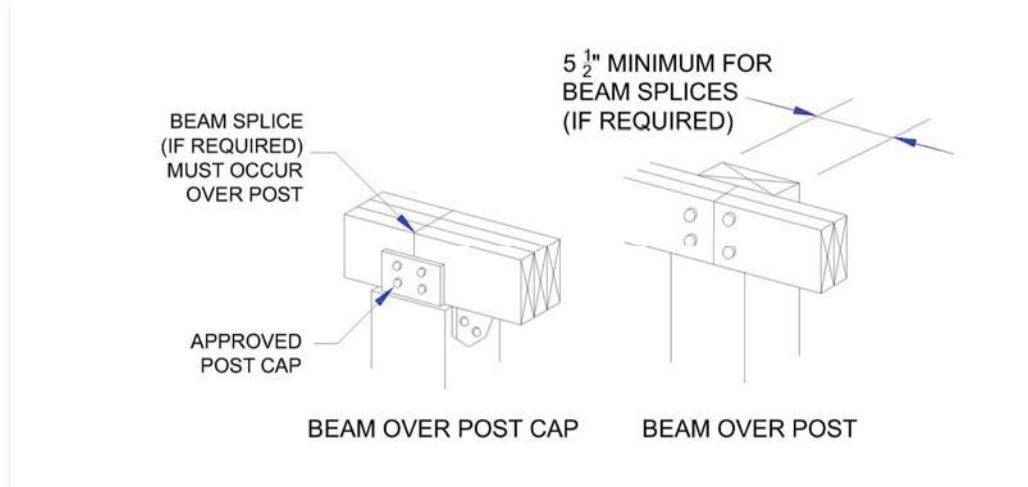

FIGURE 507.5
TYPICAL DECK JOIST SPANS

507.5.1 Deck beam bearing. The ends of beams shall have not less than 1½ - inches (38 mm) of bearing on wood or metal and not less than 3 -inches (76 mm) of bearing on concrete or masonry for the entire width of the beam. Where multiple-span beams bear on intermediate posts, each ply must have full bearing on the post in accordance with Figures 507.5.1(1) and 507.5.1(2).

507.5.2 Deck beam connection to supports. Deck beams shall be attached to supports in a manner capable of transferring vertical loads and resisting horizontal displacement. Deck beam connections to wood posts shall be in accordance with Figures 507.5.1(1) and 507.5.1(2). Manufactured post-to-beam connectors shall be sized for the post and beam sizes. Bolts shall have washers under the head and nut.



For SI: 1 inch = 25.4 mm.

FIGURE 507.5.1(1)
DECK BEAM TO DECK POST

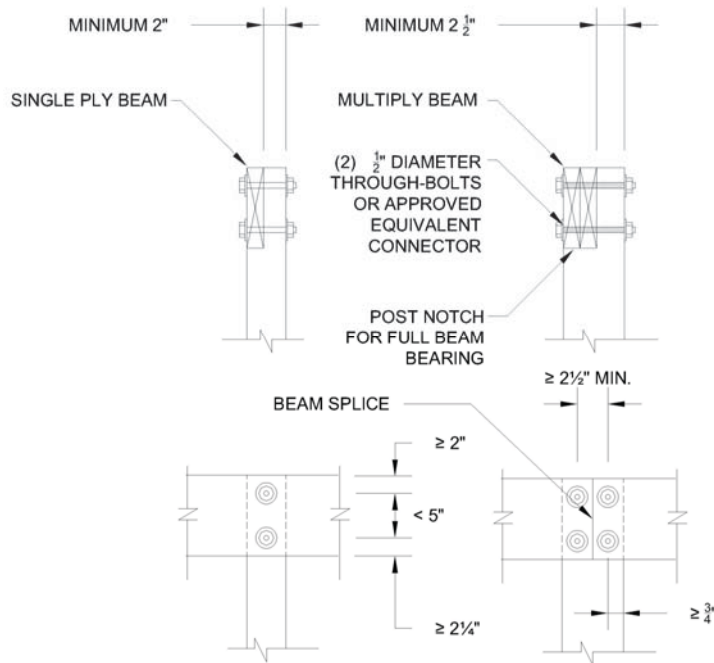

For SI: 1 inch = 25.4 mm.

FIGURE 507.5.1(2)
NOTCHED POST-TO-BEAM CONNECTION

507.6 Deck joists. Maximum allowable spans for wood deck joists, as shown in Figure 507.6, shall be in accordance with Table 507.6. The maximum joist spacing shall be limited by the decking materials in accordance with Table 507.7. The maximum joist cantilever shall be limited to one-fourth of the joist span or the maximum cantilever length specified in Table 507.6, whichever is less.

507.6.1 Deck joist bearing. The ends of joists shall have not less than 1¹/₂ - inches (38 mm) of bearing on wood or metal and not less than 3 -inches (76 mm) of bearing on concrete or masonry over its entire width. Joists bearing on top of a multiple-ply beam or ledger shall be fastened in accordance with Table 602.3(1). Joists bearing on top of a single-ply beam or ledger shall be attached by a mechanical connector. Joist framing into the side of a beam or ledger board shall be supported by approved joist hangers.

507.6.2 Deck joist lateral restraint. Joist ends and bearing locations shall be provided with lateral resistance to prevent rotation. Where lateral restraint is provided by joist hangers or blocking between joists, their depth shall equal not less than 60 percent of the joist depth. Where lateral restraint is provided by rim joists, they shall be secured to the end of each joist with not fewer than three 10d (3-inch by 0.128-inch) (76 mm by 3.3 mm) nails or three No. 10 x 3-inch (76 mm) long wood screws.

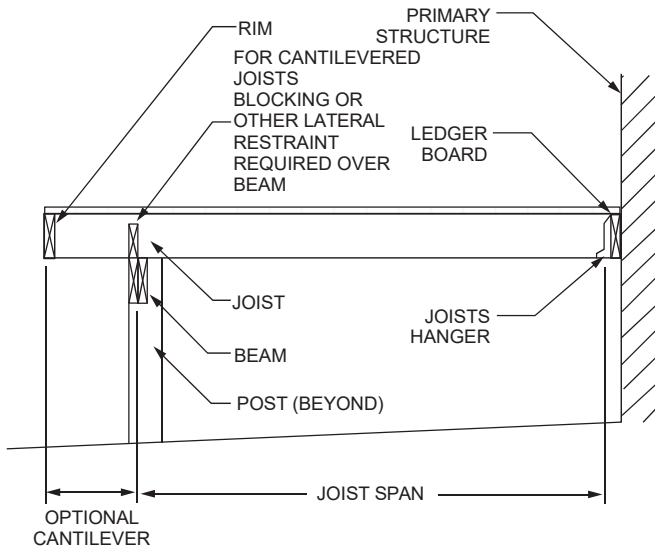

CANTILEVERED JOISTS WITH DROPPED BEAM

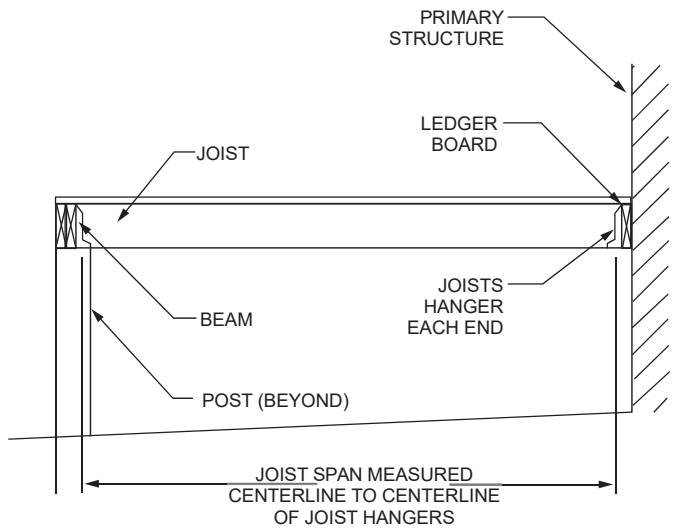

JOISTS WITH FLUSH BEAM

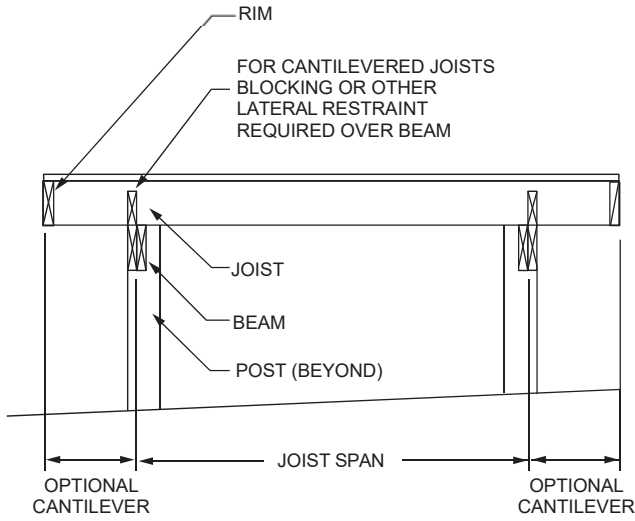

JOISTS ON FREE-STANDING DECK WITH DROPPED BEAM

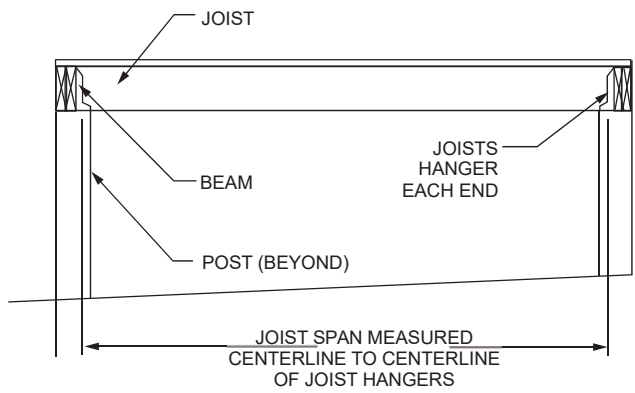

JOISTS ON FREE-STANDING DECK WITH FLUSH BEAM

FIGURE 507.6
TYPICAL DECK JOIST SPANS

**TABLE 507.6
DECK JOIST SPANS FOR COMMON LUMBER SPECIES (ft. - in.)**

SPECIES ^a	SIZE	ALLOWABLE JOIST SPAN ^b			MAXIMUM CANTILEVER ^{c, f}		
		SPACING OF DECK JOISTS (inches)			SPACING OF DECK JOISTS WITH CANTILEVERS ^c (inches)		
		<u>12</u>	<u>16</u>	<u>24</u>	<u>12</u>	<u>16</u>	<u>24</u>
Southern pine	2 x 6	<u>9-11</u>	<u>9-0</u>	<u>7-7</u>	<u>1-3</u>	<u>1-4</u>	<u>1-6</u>
	2 x 8	<u>13-1</u>	<u>11-10</u>	<u>9-8</u>	<u>2-1</u>	<u>2-3</u>	<u>2-5</u>
	2 x 10	<u>16-2</u>	<u>14-0</u>	<u>11-5</u>	<u>3-4</u>	<u>3-6</u>	<u>2-10</u>
	2 x 12	<u>18-0</u>	<u>16-6</u>	<u>13-6</u>	<u>4-6</u>	<u>4-2</u>	<u>3-4</u>
Douglas fir-larch ^d , hem-fir ^d , spruce-pine-fir ^d	2 x 6	<u>9-6</u>	<u>8-8</u>	<u>7-2</u>	<u>1-2</u>	<u>1-3</u>	<u>1-5</u>
	2 x 8	<u>12-6</u>	<u>11-1</u>	<u>9-1</u>	<u>1-11</u>	<u>2-1</u>	<u>2-3</u>
	2 x 10	<u>15-8</u>	<u>13-7</u>	<u>11-1</u>	<u>3-1</u>	<u>3-5</u>	<u>2-9</u>
	2 x 12	<u>18-0</u>	<u>15-9</u>	<u>12-10</u>	<u>4-6</u>	<u>3-11</u>	<u>3-3</u>
Redwood, western cedars, ponderosa pine ^e , red pine ^e	2 x 6	<u>8-10</u>	<u>8-0</u>	<u>7-0</u>	<u>1-0</u>	<u>1-1</u>	<u>1-2</u>
	2 x 8	<u>11-8</u>	<u>10-7</u>	<u>8-8</u>	<u>1-8</u>	<u>1-10</u>	<u>2-0</u>
	2 x 10	<u>14-11</u>	<u>13-0</u>	<u>10-7</u>	<u>2-8</u>	<u>2-10</u>	<u>2-8</u>
	2 x 12	<u>17-5</u>	<u>15-1</u>	<u>12-4</u>	<u>3-10</u>	<u>3-9</u>	<u>3-1</u>

For SI: 1 inch = 25.4 mm, 1 foot = 304.8 mm, 1 pound per square foot = 0.0479 kPa, 1 pound = 0.454 kg.

- a. No. 2 grade with wet service factor.
- b. Ground snow load, live load = 40 psf, dead load = 10 psf, L/A = 360.
- c. Ground snow load, live load = 40 psf, dead load = 10 psf, L/A = 360 at main span, L/A = 180 at cantilever with a 220-pound point load applied to end.
- d. Includes incising factor.
- e. Northern species with no incising factor.
- f. Cantilevered spans not exceeding the nominal depth of the joist are permitted.

507.7 Decking. Maximum allowable spacing for joists supporting decking shall be in accordance with Table 507.7. Wood decking shall be attached to each supporting member with not less than two 8d threaded nails or two No. 8 wood screws. Other approved decking or fastener systems shall be installed in accordance with the manufacturer's installation requirements.

**TABLE 507.7
MAXIMUM JOIST SPACING FOR DECKING**

DECKING MATERIAL TYPE AND NOMINAL SIZE	MAXIMUM ON-CENTER JOIST SPACING	
	Decking perpendicular to joist	Decking diagonal to joist ^a
1 1/2 -inch-thick wood	<u>16 inches</u>	<u>12 inches</u>
2-inch-thick wood	<u>24 inches</u>	<u>16 inches</u>
Plastic composite	In accordance with Section 507.2	In accordance with Section 507.2

For SI: 1 inch = 25.4 mm, 1 foot = 304.8 mm, 1 degree = 0.01745 rad.

- a. Maximum angle of 45 degrees from perpendicular for wood deck boards.

507.8 Vertical and lateral supports. Where supported by attachment to an

exterior wall, decks shall be positively anchored to the primary structure and designed for both vertical and lateral loads. Such attachment shall not be accomplished by the use of toenails or nails subject to withdrawal. For decks with cantilevered framing members, connection to exterior walls or other framing members shall be designed and constructed to resist uplift resulting from the full live load specified in Table 301.5 acting on the cantilevered portion of the deck. Where positive connection to the primary building structure cannot be verified during inspection, decks shall be self-supporting.

507.9 Vertical and lateral supports at band joist. Vertical and lateral supports for decks shall comply with this section.

507.9.1 Vertical supports. Vertical loads shall be transferred to band joists with ledgers in accordance with this section.

507.9.1.1 Ledger details. Deck ledgers shall be a minimum 2-inch by 8-inch (51 mm by 203 mm) nominal, pressure-preservative-treated Southern pine, incised pressure-preservative-treated hem-fir, or approved, naturally durable, No. 2 grade or better lumber. Deck ledgers shall not support concentrated loads from beams or girders. Deck ledgers shall not be supported on stone or masonry veneer.

507.9.1.2 Band joist details. Band joists supporting a ledger shall be a minimum 2-inch-nominal (51 mm), solid-sawn, spruce-pine-fir or better lumber or a minimum 1-inch by 9¹/₂-inch (25 mm by 241 mm) dimensional, Douglas fir or better, laminated veneer lumber. Band joists shall bear fully on the primary structure capable of supporting all required loads.

507.9.1.3 Ledger to band joist details. Fasteners used in deck ledger connections in accordance with Table 507.9.1.3(1) shall be hot-dipped galvanized or stainless steel and shall be installed in accordance with Table 507.9.1.3(2) and Figures 507.9.1.3(1) and 507.9.1.3(2).

507.9.1.4 Alternate ledger details. Alternate framing configurations supporting a ledger constructed to meet the load requirements of Section 301.5 shall be permitted.

TABLE 507.9.1.3(1)
DECK LEDGER CONNECTION TO BAND JOIST ^{a, b}
 (Deck live load = 40 psf, deck dead load = 10 psf, snow load ≤ 40 psf)

CONNECTION DETAILS	JOIST SPAN						
	6' and less	6' 1" to 8'	8' 1" to 10'	10' 1" to 12'	12' 1" to 14'	14' 1" to 16'	16' 1" to 18'
	On-center spacing of fasteners						
<u>1/2 -inch diameter lag screw with 1/2 -inch maximum sheathing</u> ^{c, d}	30	23	18	15	13	11	10
<u>1/2 -inch diameter bolt with 1/2 -inch maximum sheathing</u> ^d	36	36	34	29	24	21	19
<u>1/2 -inch diameter bolt with 1-inch maximum sheathing</u> ^e	36	36	29	24	21	18	16

For SI: 1 inch = 25.4 mm, 1 foot = 304.8 mm, 1 pound per square foot = 0.0479 kPa.

- a. Ledgers shall be flashed in accordance with Section 703.4 to prevent water from contacting the house band joist.
- b. Snow load shall not be assumed to act concurrently with live load.
- c. The tip of the lag screw shall fully extend beyond the inside face of the band joist.
- d. Sheathing shall be wood structural panel or solid sawn lumber.
- e. Sheathing shall be permitted to be wood structural panel, gypsum board, fiberboard, lumber or foam sheathing. Up to 1/2 -inch thickness of stacked washers shall be permitted to substitute for up to 1/2 -inch of allowable sheathing thickness where combined with wood structural panel or lumber sheathing.

TABLE 507.9.1.3(2)
PLACEMENT OF LAG SCREWS AND BOLTS IN
DECK LEDGERS AND BAND JOISTS

	MINIMUM END AND EDGE DISTANCES AND SPACING			
	TOP EDGE	BOTTOM EDGE	ENDS	ROW SPACING
<u>Ledger</u> ^a	2 inches ^d	3/4 -inch	2 inches ^b	1 5/8 inches ^b
<u>Band Joist</u> ^c	3/4 -inch	2 inches	2 inches ^b	1 5/8 inches ^b

For SI: 1 inch = 25.4 mm.

- a. Lag screws or bolts shall be staggered from the top to the bottom along the horizontal run of the deck ledger in accordance with Figure 507.9.1.3(1).
- b. Maximum 5 inches.
- c. For engineered rim joists, the manufacturer's recommendations shall govern.
- d. The minimum distance from bottom row of lag screws or bolts to the top edge of the ledger shall be in accordance with Figure 507.9.1.3(1).

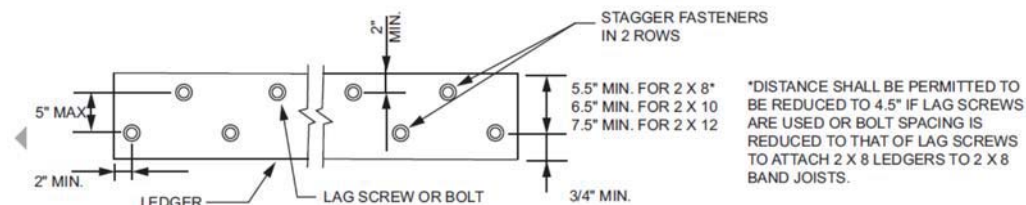

For SI: 1 inch = 25.4 mm.

FIGURE 507.9.1.3(1)
PLACEMENT OF LAG SCREWS AND BOLTS IN LEDGERS

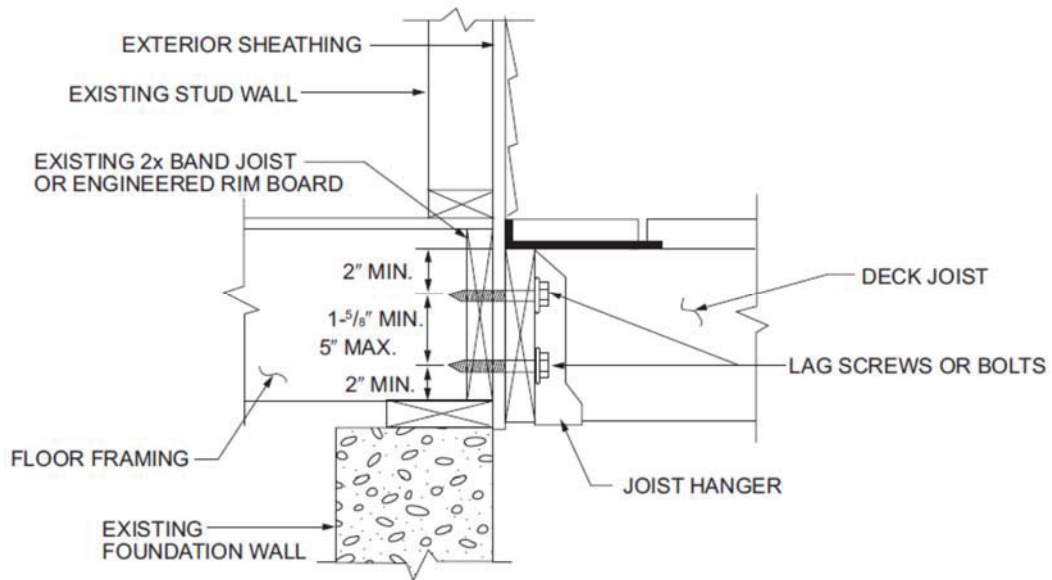

For SI: 1 inch = 25.4 mm.

FIGURE 507.9.1.3(2)
PLACEMENT OF LAG SCREWS AND BOLTS IN BAND JOISTS

507.9.2 Lateral connection. Deleted

Delete Figure

FIGURE 507.9.2(1)
DECK ATTACHMENT FOR LATERAL LOADS

Delete Figure

FIGURE 507.9.2(2)
DECK ATTACHMENT FOR LATERAL LOADS